



ecotech

environmental monitoring solutions

8301 Series

Compressed Air Source

User Manual

Version: 1.7

November 2012

www.ecotech.com

This page is intentionally blank

Introduction

Thank you for purchasing an 8301-series Compressed Air Source. The series currently includes the following configurations:

Model	Description
8301LC	Standard flow compressed air source with logic control (0-10 litres/minute)
8301LC-H	High flow compressed air source (0-20 litres/minute)
8301P	Portable compressed air source (0-10 litres/minute)

Model 8301 and 8301-H without logic control (LC) are also available.

Please take the time to read this manual. It contains important information about operating the air source. If, after reading this manual, you have any questions or are unsure about any part of the air source, please don't hesitate to contact Ecotech. Ecotech also welcomes any suggestions or feedback that you may have on this product. If there are any improvements that you feel would make this a more useable and helpful product then please send your suggestions to Ecotech.

When contacting us please provide the model number and serial number. If you are reporting a problem please include steps required to reproduce that problem.



Please help the environment and recycle the pages of this manual when you've finished using it.

Notice

The information contained in this manual is subject to change without notice. Ecotech reserves the right to make changes to equipment construction, design, specifications and /or procedures without notice.

Copyright © 2012. All rights reserved. Reproduction of this manual, in any form, is prohibited without the written consent of Ecotech Pty Ltd



WARNING

Hazardous voltages exist within the instruments housing. Ensure the side and rear enclosure panels are always in place when the instrument is connected to the mains. Ensure the power cord, plugs and sockets are maintained in a safe working condition. This instrument is only recommended for indoor use.

Ecotech recommends the use of Earth-Leakage Protection Circuit Breakers (ELCB) on the power supply to the HTO-1000. If operating from a generator, power conditioner, isolation transformer, or other floating supply, ensure that a suitable separate earth connection is established.



CAUTION

When operating for prolonged periods of time, the head of the pump can exceed 70°C. Avoid touch the pump.

Safety requirements

- To reduce the risk of personal injury caused by electrical shock, follow all safety notices and warnings in this documentation.
- If the equipment is used for purposes not specified by Ecotech, the protection provided by this equipment may be impaired.
- Replacement of any part should only be carried out by qualified personnel, using only parts specified by Ecotech as these parts meet stringent Ecotech quality assurance standards. Always disconnect power source before removing or replacing any components.

Warranty

This product has been manufactured in an ISO 9001, AS/NZS 4801: 2001 and ISO 14000 and facility with care and attention to quality, safety and environment.

The product is subject to a 24-month warranty on parts and labour from date of shipment (the warranty period). The warranty period commences when the product is shipped from the factory. Lamps, fuses, batteries and consumable items are not covered by this warranty.

Each analyser is subjected to a vigorous testing procedure prior to despatch and will be accompanied with a parameter list and a multipoint calibration check thereby enabling the analyser to be installed ready for use.

Service & repairs

Our qualified and experienced technicians are available to provide fast and friendly service five days a week, Monday to Friday. You can speak to a real person regarding any questions you have about your unit and we will respond within 48 hours.

Service Guidelines

In the first instance, please call or email us if you are experiencing any problems or issues with your unit.

Contact our Service Response Centre via email on service@ecotech.com.au or call +61 (0) 3 9730 7848

If we cannot resolve the problem through technical support, please **email** the following information:

- Name and phone number
- Company name
- Shipping address
- Quantity of items being returned
- Model number/s or a description of each item
- Serial number/s of each item (if applicable)
- A description of the problem. For example, if a factory repair is needed, or the reason you are returning the equipment (eg, sales return, warranty return, etc)
- Original sales order or invoice number related to the equipment.

When you email us we will assign a Return Material Authorization (RMA) number to your shipment and initiate the necessary paperwork to process your equipment within 48 hours. Please include this RMA number when you return equipment, preferably both inside and outside the shipping container. This will ensure you receive prompt service.

CE Mark Declaration of Conformity

This declaration applies to the 8301LC series Compressed Air Source as manufactured by Ecotech Pty. Ltd. of 1492 Ferntree Gully Rd, Knoxfield, VIC, 3180, Australia. This declaration relates is in conformity with the following European Union Directives:

Council Directive of 15 December 2004 on the approximation of the laws of Member States relating to electromagnetic compatibility (2004/108/EC)

The following standard was applied:

EN 61326-1:2006 Electrical Equipment for measurement, control and laboratory use – EMC Requirements – Part 1: General requirements.

- Immunity Requirements EN61326-1
 - IEC-61000-4-2 Electrostatic discharge immunity
 - IEC-61000-4-3 Radiated RF immunity
 - IEC-61000-4-4 Electrical fast transient burst immunity
 - IEC-61000-4-5 Surge immunity
 - IEC-61000-4-6 Conducted RF Immunity
 - IEC-61000-4-11 Voltage dips and interruption immunity
- Electromagnetic compatibility EN61326-1
 - CISPR-11 Radiated RF emission measurements
 - CISPR-11 Mains Terminal RF emission measurements
 - IEC-61000-3-3 Mains Terminal voltage fluctuation measurements
 - IEC-61000-3-2 Power Frequency harmonic measurements

Council Directive of 12 December 2006 on the harmonization of the laws of Member States relating to electrical equipment designed for use within certain voltage limits (2006/95/EC)

The following standard was applied:

EN 61010-1:2001 Safety requirements for electrical equipment, for measurement control and laboratory use – Part 1: General requirements

- For protection against:
 - Electric shock or burn
 - Mechanical HAZARDS
 - Excessive temperature
 - Spread of fire from the equipment
 - Effects of radiation, including laser sources and sonic and ultrasonic pressure

Claims for Damaged Shipments and Shipping Discrepancies

Damaged shipments

1. Inspect all instruments thoroughly on receipt. Check materials in the container(s) against the enclosed packing list. If the contents are damaged and/or the instrument fails to operate properly, notify the carrier and Ecotech immediately.

2. The following documents are necessary to support claims:
 - a. Original freight bill and bill lading
 - b. Original invoice or photocopy of original invoice
 - c. Copy of packing list
 - d. Photographs of damaged equipment and container
 - e. Contact your freight forwarder for insurance claims

You may want to keep a copy of these documents for your records also.

Refer to the instrument name, model number, serial number, sales order number, and your purchase order number on all claims. Upon receipt of a claim, we will advise you of the disposition of your equipment for repair or replacement.







Shipping Discrepancies

Check all containers against the packing list immediately on receipt. If a shortage or other discrepancy is found, notify the carrier and Ecotech immediately. We will not be responsible for shortages against the packing list unless they are reported quickly (within 7 days).

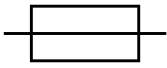
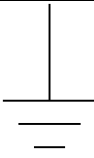
Contact Details

Head Office
1492 Ferntree Gully Road, Knoxfield VIC Australia 3180
Phone: +61 (0) 3 9730 7800 Fax: +61 (0) 3 9730 7899
Email: info@ecotech.com.au
Service: service@ecotech.com.au
www.ecotech.com.au

Internationally recognised symbols used on Ecotech Equipment

	Electrical fuse	IEC 60417-5016
	Earth (ground) terminal	IEC 60417-5017
	Protective conductor terminal	IEC 60417-5017
	Equipotentiality	IEC 60417-5021
	Alternating current	IEC 60417-5032
	Caution, hot surface	IEC 60417-5041
	Caution, risk of danger. Refer to accompanying documents	ISO 7000-0434
	Caution, risk of electric shock	ISO 3864-5036

MANUAL REVISIONS HISTORY

Edition	Date	Summary	Affected Pages
1.1	March 1999	Release	
1.2	December 2000	Update various, 8301P added	Various
1.3	June 2004	Pinout error on Gascal	8
1.4	July 2007	New Company details added	Various
1.5	January 2010	Spares and Accesories	11
1.6	May 2010	Storage tank and pressure switch option added	12
1.7	November 2012	Additions for CE Certification, Schematic Updated	Various

This page is intentionally blank

Table of Contents

Introduction3

Main Components:12

Specifications13

Functional Description.....13

Installation15

Power15

Control Input connection (DB9F) – LC models only16

Air outlet16

Water Trap Drain Outlet.....17

Scrubber Chain.....17

Maintenance and service18

Consumables.....19

Spare parts.....19

Storage tank and pressure switch option20

Main Components:

Item No.	Description
1	PUMP 230/240 VAC 50 Hz
2	MAINS INLET & FUSE
3	SOLOINOID VALVE
4	PRESSURE REGULATOR
5	REMOTE CONTROL CONNECTOR
6	AIR OUTLET

Rear View

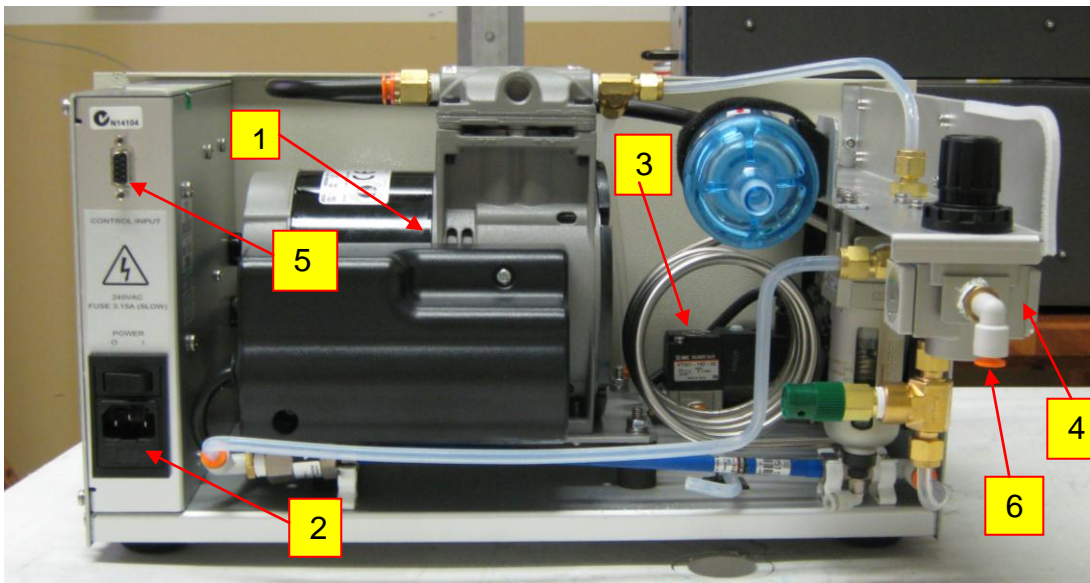

Specifications

Zero Air Flow:	0-10 l/min (for 8301LC) 0-20 l/min (for 8301LC-H)
Protection:	Pump is thermally protected.
Zero Air Pressure:	100-200 KPA
H ₂ O:	Dew-Point -15°C (nominal)
Power:	220 - 240V AC 50Hz 320VA max
Fuse:	3.15A T250 (Slo-Blow)
Environmental Conditions:	0 - 40°C, 10 – 95% RH
Maximum Altitude:	3000m.
Weight:	13Kg.

Functional Description

Used in conjunction with Ecotech gas scrubbers (containing suitable gas removal media), the 8301 Compressed Air Source makes an ideal source of dry “zero air” for gas calibrators and ambient air analysers in environmental monitoring applications.

The 8301LC series Compressed Air Source has been designed to complement the Ecotech Gascal series Dilution Calibrator. With LC (logic control) switching, the air source can be remotely switched on and off as required by the calibrator. This prolongs the life of the scrubbers and pump.

The standard unit (non “-H” models) can supply up to 10 litres per minute at pressures of up to 3 bar (300 kPa).

The high-flow unit (“-H” models) can supply up to 20 litres per minute at pressures of up to 3 bar (300 kPa). This model is suitable for use with dilution calibrators with high-range (0-10slpm) mass flow controllers.

The air source incorporates a high-quality reliable pump - a Thomas Model 607 (standard) or 627 (high flow). Air is cooled and dried within the unit. An adjustable pressure regulator sets the outlet pressure (nominally set to 200 kPa).

LC models have a pressure purge valve to allow reliable start-up when unattended.

A membrane dryer is installed as standard and reduces the dew-point of the air by removing moisture. Typical dryer performance, with ambient conditions of 50% RH and 23°C:

Model	Flow (l/min.)	Final dew point (°C)
Standard	5.0	-12
	10.0	3.5
High flow “-H”	5.0	-12
	10.0	-11
	15.0	-8.5
	20.0	5.5

Various scrubbing systems may be added to the outlet, depending on the application.

Some common examples of gas removal systems include:

Molecular sieve - Moisture removal, SO₂

Charcoal - Removal of pollutant gas components NO₂, SO₂, H₂S, low level hydrocarbons

Purafil - Removal of pollutant gas components NO_x

A heated catalytic CO scrubber is available separately for removal of Carbon Monoxide.

Installation

The 8301 series is supplied in a chassis, suitable for mounting in a 19" rack or on a bench. Rubber feet are fitted to the base of bench-mounted units. Remove these feet (if applicable) before installing the unit in a rack. The chassis takes up 5RU when mounted in a rack.

8301P models are mounted in a case that is designed to be easily transportable. 8301P models have provision for mounting the heated CO scrubber and two canister scrubbers on the sides, and are fitted with a carry handle and rubber feet. The cooling fan is fitted with an air filter.

The air source should be mounted in a clean and dry area, away from direct heat sources. Avoid mounting the unit on the floor as dust will be drawn into the pump and fan. Adequate ventilation should also be provided to ensure overheating does not occur. Although a rugged device, clean and air-conditioned environments will provide the best operating conditions for the Air Source. Allow some space around the unit for ventilation. Allow adequate space at the rear of the air source as all connections and the Master on/off switch are on the rear of the unit.

Power



The air source must be operated from the correct voltage. Two options are available: 110-120 VAC 60Hz and 220-240 VAC 50Hz. The inlet connector is labelled to show input voltage requirements. The power inlet is on the rear of the 8301LC and accepts a standard IEC power lead.

Ensure the supply voltage is correct before applying power to the unit. The power consumption of all models is approximately 320VA. Earth should be provided via the AC power plug to ensure safe operation. A Power Conditioner is not normally recommended or required unless the mains power supply is unreliable.

A fuse is installed in the power inlet at the rear of the 8301LC. Ensure that the fuse is rated to 250VAC and 3.15A with time delay as marked on the rear of the instrument.

Control Input connection (DB9F) – LC models only

The Control Input port is a DB-9 female connector on the rear above the power connections. The port is used to switch the air source on and off via remote control. A solid state relay inside the 8301LC is used to switch the mains power to the pump, purge valve and cooling fan. The relay typically sinks 10-12 mA. The port is normally connected to a calibrator, such as the Ecotech Gascal, via a standard 9-pin RS-232 serial cable. The pin-outs are provided below, in case an alternative control method is used.

Control Input Connection:

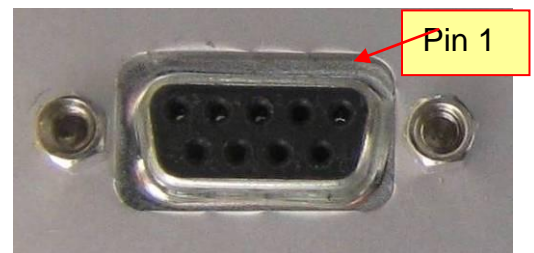

<u>Pin</u>	<u>Function</u>	<u>Gascal pin-out</u>
2	+3 to 32 VDC to activate air source	J6-2 (12V)
6	0 VDC	J6-6 (Ground)
Other pins	Not used	

Air outlet

The air outlet is a ¼” push-in connector on the output of the adjustable pressure regulator (where the pressure gauge is mounted.) No inlet connection is required as the pump draws from ambient air via a replaceable DFU filter. When used with the Ecotech Gascal dilution calibrator, the regulated output pressure should be adjusted at the regulator to 28 psig (200 kPa).

Water Trap Drain Outlet



The water trap drain outlet located at the bottom of the water trap should be connected to a 1/8 tubing and drained well away from any electrical connections of this or any other equipment.

Scrubber Chain

The optional gas scrubbers form a chain of gas removal media that effectively removes a broad range of gases, producing what is commonly referred to as “zero air”.

It is important that the scrubbing media is correct for removing the gases that are of interest, usually the gases being analysed.

It is also important that the scrubbing media is replaced at regular intervals, determined by the level of local pollutants. The scrubbers can be opened, and the contents replenished with new scrubbing media. Molecular sieve may need to be replaced at more frequent intervals due to high local relative humidity conditions.

The scrubber sequence is important for correct gas removal. The sequence is:

8301LC → Optional Molecular Sieve scrubber with indicator → Optional Purafil scrubber → Optional Charcoal scrubber. (The arrows indicate the direction of air flow).

The optional Ecotech Heated CO Scrubber should be plumbed into the 8301LC between the output of the filter coalescor and the input of the membrane dryer. A DFU filter should be installed on the outlet of the HCS-1000 scrubber to prevent blocking the membrane dryer. See the plumbing diagram for details. 8301P models may have the CO scrubber already installed. All DFU filters are located inside the air source on the 8301P models.

Write the date of installation on the scrubber and in a log-book, so that the media is replaced at the correct intervals.

After replacing the scrubbing media, perform a leak check on the scrubber by pressurising it slightly (200-300kPa) and applying “Snoop” leak detector. Note that during normal operation, the scrubber pressure must not exceed 200 kPa gauge-pressure (28psi-g).

Maintenance and service

Active ingredients of the molecular sieve and scrubber must be changed at regular intervals, depending on the quality of the inlet air. Generally 4-6 weeks of continuous use is considered a suitable replacement period. The DFU filter on the inlet to the pump should also be replaced periodically. A new DFU filter should be installed so that the outside of the filter element traps the particles as this enables a visual inspection of the filter condition to be made. The filter should be replaced at least every 6 months regardless of visual condition, but more frequently if the filter element is no longer white.

An additional DFU filter is fitted to units fitted with the heated CO scrubber.

The pressure relief valve is factory set at 500kPa. It may be adjusted if necessary by removing the green cap, setting the pressure regulator at 500kPa, and adjusting the valve with a hex key until air can be heard bleeding off from the relief valve. Then replace the green cap and reset the regulator to 200kPa.

If the pump fails to start, a thermal overload protects the windings from damage. Failure to start may be caused by a build-up of pressure in the output line, which will normally bleed off after a few seconds, and the pump will then start-up normally. On LC models, a purge valve vents the pressure when the pump is switched off, either via the Control Input or at the Power switch on the rear of the 8301LC. If the pump fails to start, the line may be blocked. Investigate the source of the blockage.

8301P models have a fan filter that should be periodically removed and flushed clean with water.

Consumables

DFU	F010005
Pump kit (standard)	P031001
Pump kit (High flow only)	PUM-1055

Spare parts

Dryer	ECO-1DG102
Solenoid Assembly (240V)	H050027
Solenoid Assembly (115V)	H050027-01
Fan assembly (240V)	H050026
Fan assembly (110V)	H050026-01
Pump (240V)	P030004
Pump (115V)	P030005
High Flow pump (240V)	PUM-1002
High Flow pump (115)	PUM-1002-115V

Storage tank and pressure switch option

Precautions

- The tank system contains compressed air. Usual precautions apply.
- Before servicing any of the components in the system (including scrubber replacement) switch the power supply off and de-pressurise the system carefully before removing scrubbers or other items.

Assembly

- Follow the schematic diagram at the end of this document for the correct plumbing of components.
- The filter coalescor located after the tank is removed for shipping. Attach the coalescor to the tank as per the photo above. Tighten the fittings as per Swagelok recommendations - do not over-tighten the brass fittings. Check all other fittings are secure.
- Mount the tank in vertical orientation. The tank is best located in a cool area (eg. Near an air conditioner that blows cool air) as it will drop out any moisture which can then be removed by the coalescor.
- Attach tubing as per the plumbing diagram. Tighten the ¼" fittings as per Swagelok recommendations.



Function

- The tank option provides storage of compressed air so that the pump does not run continuously. The tank option includes a pressure switch installed on the rear of the 8301LC and a check valve installed before the tank.
- This option is useful for situations where a small amount of air is continually required (eg. For supplying 250cc/min to a FID hydrocarbon analyser)
- The pump and fan will switch on and off as required. Eg. At 250cc/min outlet flow from the system, the pump will switch on for about 20 seconds in every 90 seconds. This reduces power consumption and heat buildup which in turn improves (lowers) the dew point.
- The logic control cable from the Gascal will over-ride the function of the pressure switch. This means, during calibrations requiring zero air, the pump will remain on.
- Set the 8301LC regulator to no more than 4 bar (otherwise the relief valve will activate and release pressure from the system. This is important as the plastic scrubbers must not be over-pressurised).

Specifications

- Pump Duty cycle at 250cc/min outlet flow – around 20sec per 90sec
- Storage 1.8 litres
- Switch pressure 6bar(g)
- All else as per 8301LC manual

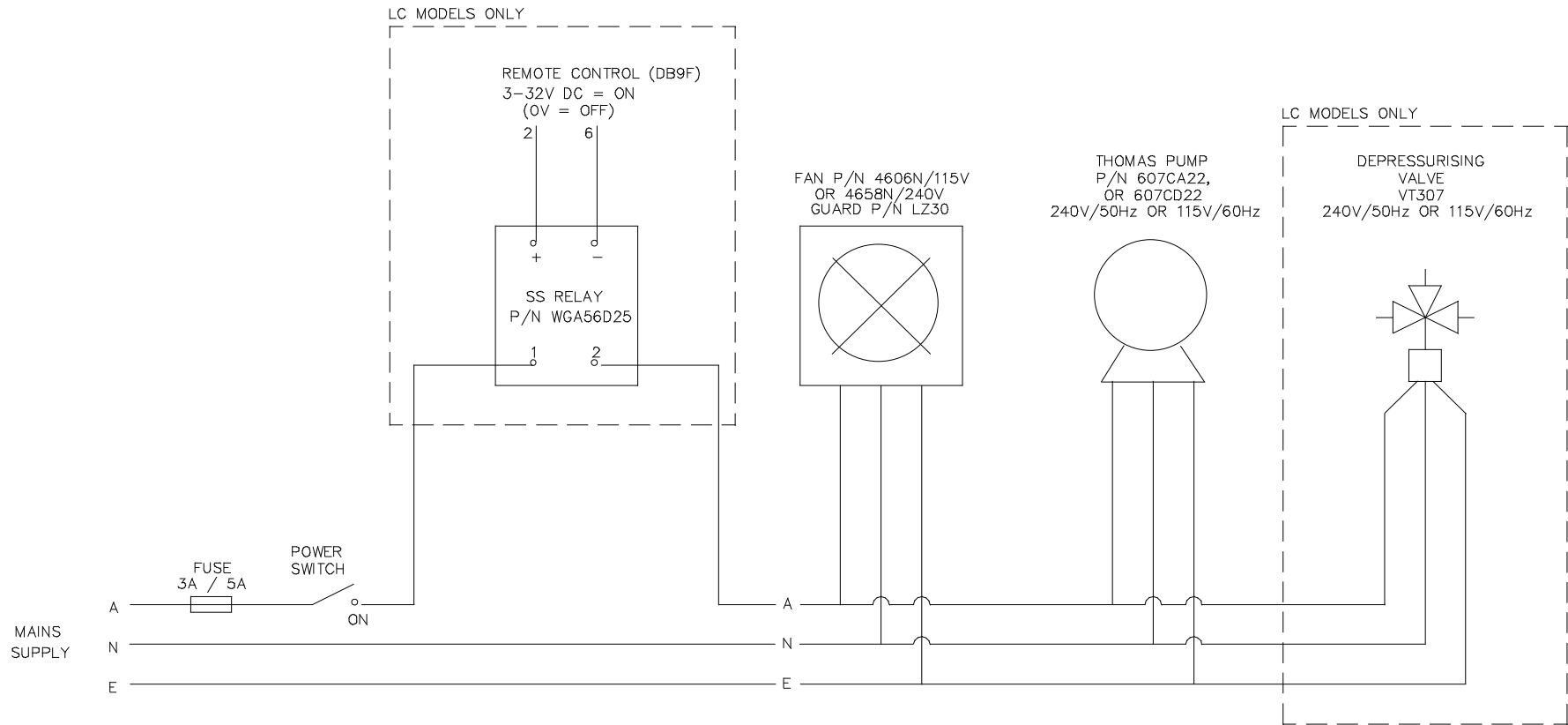

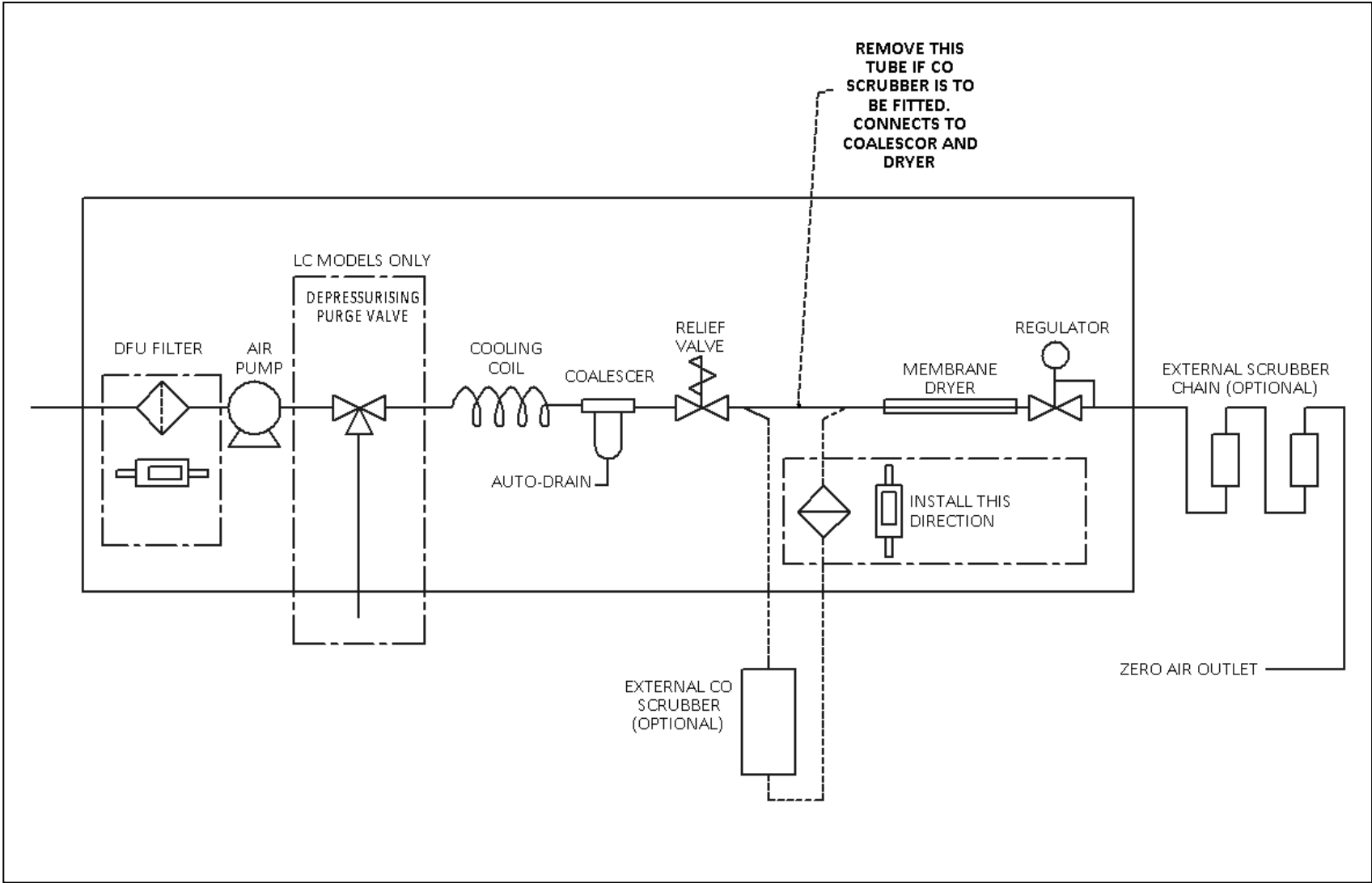



1492 Ferntree Gully Road, Knoxfield VIC Australia 3180
Phone: +61 (0) 3 9730 7800 Fax: +61 (0) 3 9730 7899
Email: info@ecotech.com.au
Service: service@ecotech.com.au
www.ecotech.com